



- 100% NON-PROPRIETARY CONTROL SYSTEM
- AI POWERED DOSING INTELLIGENTLY LEARNS AND UNDERSTANDS YOUR PRODUCT
- TOOL-LESS DISASSEMBLY IN UNDER 30 SECONDS
- 6" USER-FRIENDLY TOUCHSCREEN
- HEAVY-DUTY 304 STAINLESS STEEL CONSTRUCTION
- INDUSTRY-LEADING SCALE RESOLUTION
- ALL ELECTRIC (NO AIR REQUIRED)
- SIMPLE PLUG AND PLAY INTERFACE TO AUXILIARY EQUIPMENT



 WWW.DURA-PACK.COM  SALES@DURA-PACK.COM  313.299.9600

7641 HOLLAND ROAD | TAYLOR, MICHIGAN 48180



DL-215

**AUTOMATED VIBRATORY
FILLING MACHINE**

SPECIFICATIONS

- CAPACITY (WEIGHT/VOLUME): 5kg/5 LITER
- SCALE RESOLUTION: 0.2g
- ACCURACY: 1% OR BETTER
(TYPICAL, PRODUCT DEPENDENT)
- SPEED: UP TO
40 CYCLES/MIN
- POWER: 120/240 VAC, 1PH,
60HZ, 20A

OPTIONS

- DIMPLED CONTACT SURFACE
- NON-STICK COATINGS
- LEVEL SENSING
- HIGH DUST/POWDER
HANDLING
- INDEXING CONVEYOR FOR
FILLING RIGID CONTAINERS
- POUCH FILLING EQUIPMENT
- POUCH SEALERS
- ADJUSTABLE STAND WITH
CASTERS (STAINLESS OR
MILD STEEL)
- CUSTOM CONFIGURATIONS

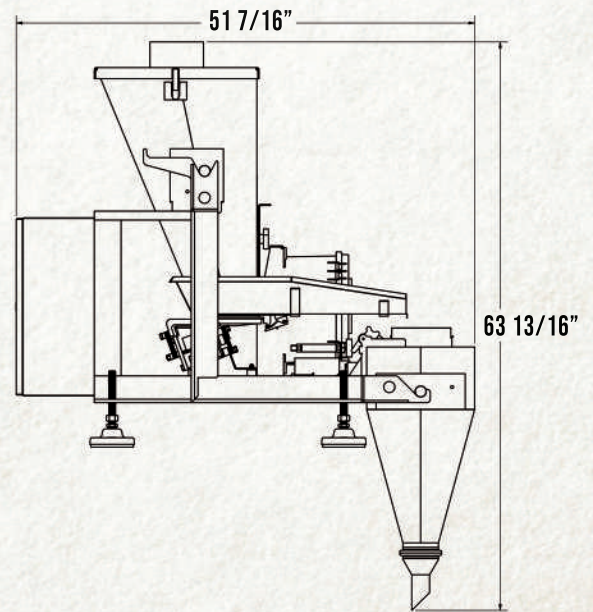
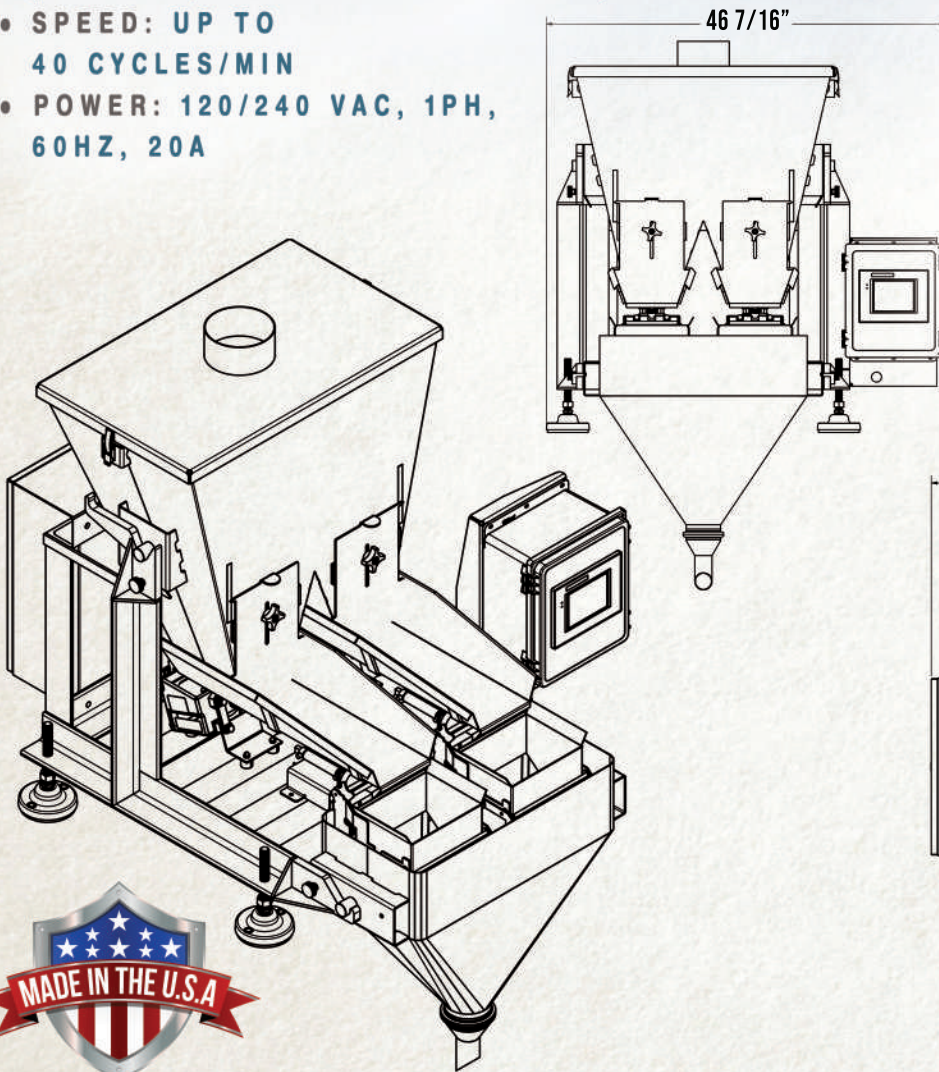

 WWW.DURA-PACK.COM  SALES@DURA-PACK.COM  313.299.9600

7641 HOLLAND ROAD | TAYLOR, MICHIGAN 48180

DURA-PACK
Driven by Cost. Defined by Quality.